

BLANKETS & STRIPPING PLATES

AtéCé
GRAPHIC PRODUCTS







AtéCé Graphic Products has a very modern production environment for the converting of printing, stripping and self-adhesive blankets. AtéCé is one of the leading companies in this field with years of experience and a high level of expertise. AtéCé can develop blankets with manufacturers to meet their specifications.

- **Printing blankets**
- **Stripping blankets**
- **Coating plates**
- **Self-adhesive**
- **Bars**
- **Plotters**
- **Specialties**

 **ISEGA**

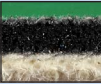

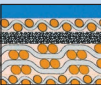
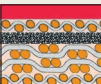
PrintCare
blankets & stripping plates

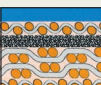
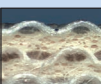
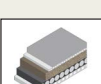
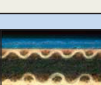
Printing blankets		Sheetfed									Web		Key features
Product PrintCare		Colour	High quality printing	Large offset presses	Cartons	Metal printing	Plastic printing	UV	Hybrid	Coldset	Heatset		
	Azure Thickness 1.95 mm	Blue	•••	•••	••							<ul style="list-style-type: none"> - Exceptional stable on press - Excellent quick release - Low gauge lost - Sharp dot reproduction and smooth solids 	
	Adventure Thickness 1.95 mm	Green	•••	•••	•••	••						<ul style="list-style-type: none"> - New fabric construction for low stretch - Long durability and long life - 3 ply - Outstanding edge marking resistance 	
	Amici Pro Thickness 1.70 and 1.97 mm	Blue	••	••	••	••	•		•	•		<ul style="list-style-type: none"> - General Sheetfed - Good price/quality ratio - Good solid printing 	
	Amici Combi Thickness 1.95 mm	Blue	•••	•••	••	•••		•	•••			<ul style="list-style-type: none"> - 4 ply - Good quick release - Hybrid 	
	Amici Pro UV Thickness 1.70 and 1.95 mm	Red	•••	•••	•••	••		•••				<ul style="list-style-type: none"> - EPDM surface rubber - Good resistance against UV inks - Resistance for most UV washes - Good QR properties 	
	SF-Diamond Thickness 1.70 and 1.97 mm	Blue	••	••	••	••	•		•	•		<ul style="list-style-type: none"> - General Sheetfed - Good price/quality ratio - Good solid printing 	
	SF-Platinum Thickness 1.95 mm	Blue	•••	•••	••	••		•	•••			<ul style="list-style-type: none"> - 4 ply - Good quick release - Hybrid 	
	Hybrid Thickness 1.95 mm	Blue-Green	•••	••	•••	••		•	••			<ul style="list-style-type: none"> - Very good smash resistance - Excellent quick release - No problems with format changes - Hybrid 	
	Titanium Thickness 1.95 mm	Grey	•••	•••	•••				••			<ul style="list-style-type: none"> - Unique patented nylon cord carcass technology - Ability to print short run UV, metallic and speciality printing inks - Absolute minimal sinking and stretch characteristics 	
	HS-Elite Thickness 1.70 and 1.95 mm	Blue	•••	•••						•	•••	<ul style="list-style-type: none"> - Good heatset and large format sheetfed blanket - Good paper feeding - Stable press behavior 	

••• = Very good •• = Good • = Suitable

19.03

PrintCare plotters

Type	Camera *	Cutting area
PrintCare plotter LST o604-RM	Yes	600 x 400 mm
PrintCare plotter 15C	Yes	1380 x 800 mm
PrintCare plotter 15	No	1500 x 1100 mm
PrintCare plotter 20	No	2000 x 1250 mm
PrintCare plotter 25	No	2500 x 1650 mm
PrintCare plotter CB03-II 1816	Yes	1800 x 1600 mm

*) for print mark recognition

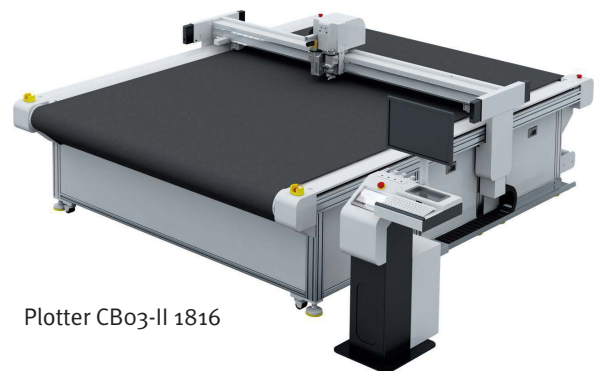









Plotter CB03-II 1816

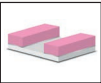

Ask AtéCé

AtéCé has over 40,000 graphics consumables in its product range. But what if you cannot find the product you are looking for? Just send a mail to info@atece.com or call +31 (0)251 31 91 09. We can help you find the right product and/or custom solution.

Stripping blankets		Sheetfed				Key features
Product PrintCare	Colour	Spot coating WB	Spot coating UV	Repeat coating jobs		
 StripperOne Thickness 1.96 mm	Blue	•••	•	•	<ul style="list-style-type: none"> - Sharp edges and good coating transfer - Relief depth 0.80 mm - Easy to peel - Cutting by hand or cad table possible 	
 StripperBlue Thickness 1.95 mm	Blue/ Green	•••	•••	•	<ul style="list-style-type: none"> - Very good coating transfer - Cutting by hand or cad table possible - Relief depth 0.80 mm - Easy to peel 	
 Polymer Superior Dikte 1.15 en 1.35 mm	Blauw	•••	••	•••	<ul style="list-style-type: none"> - Unique product specially made for AtéCé Graphic Products - Polymer - Absolutely no ink build up - Fantastic price/quality ratio! 	
 VP195 Premium Thickness 1.95 mm	Pink	•••	•••	•••	<ul style="list-style-type: none"> - The best stripping blanket, environmentally friendly - Relief depth 1.30 mm - No ink build up - Compressible layer 	
 Polymer Thickness 1.15 and 1.35 mm	Pink	•••	••	•••	<ul style="list-style-type: none"> - Unique product made for AtéCé Graphic Products - Polymer with a compressible layer - No ink build up - Environmentally friendly 	
 Polymer Xtra Thickness 1.15 and 1.35 mm	Redish	•••	•••	•••	<ul style="list-style-type: none"> - For special coatings like deep matt and soft touch - Polymer - No ink build up - Environmentally friendly 	
 Premium Coat Thickness 1.15, 1.35 and 1.95 mm	Green	•••	••	•••	<ul style="list-style-type: none"> - Coating plate with a compressible layer - Suitable for UV and waterbased coating - Improved coating transfer, lowest ink build-up and extended wash intervals 	
 SSSB Thickness 0.95 and 1.15 mm (Self adhesive coating blanket)	Blue- Green	•••	•••	•••	<ul style="list-style-type: none"> - Self adhesive product made for AtéCé Graphic Products - Suitable for WB and UV - No ink build up - Only available on rolls 	
 Extreme UV Thickness 1.15 and 1.35 mm	Black	••	•••	•••	<ul style="list-style-type: none"> - Extreme suitable for UV coating - EPDM rubber - Hard to peel 	

••• = Very good •• = Good • = Suitable

19.03

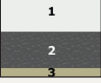
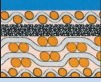
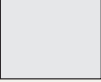
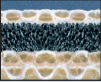
Specialties		Sheetfed							Key features	
Product PrintCare	Colour	High quality printing	Large offset presses	Cartons	Metal printing	2-pc Can application	Plastic printing	UV		Hybrid
 Cup Star Thickness 1.95, 2.5, 3.2 and 3.90 mm (Not adhesive)	White						•••			<ul style="list-style-type: none"> - Suitable for UV and conventional dry-offset inks - Processing temperature between -20 and 150°C - For Polytype, Van Dam, Omsco, Kase and Desco
 MD-Superior Thickness 1.95 mm	Blue	••	••	••	•••			•	••	<ul style="list-style-type: none"> - 4 ply - Extreme robust surface - Hybrid
 SMT Thickness 1.70 mm	Blue	••	••					••	••	<ul style="list-style-type: none"> - High quality security printing - 3 ply - Perfect print and superb paper release - Suitable for hybrid & waterless printing
 2-pc Can HQ Thickness 1.96 mm	Blue					•••			••	<ul style="list-style-type: none"> - Good dot sharpness and smooth solids - 3 ply - Gauge variation of ±0.01 mm in 1 pack - Suitable for waterless printing

••• = Very good •• = Good • = Suitable

19.03

Location Alkmaar, the Netherlands



Location Uitgeest, the Netherlands



Knowledge and experience

The AtéCé professionals know exactly how to make printing and self-adhesive blankets and stripping plates of consistent quality. Several PrintCare products are Isega certified. Within the PrintCare product range, there are applications for sheetfed printing, web printing, coldset, heatset, metaldeco, 2-pc Can and plastic printing.

AtéCé also supplies a special PrintCare plotter for plotting stripping plates.

PrintCare printing and self-adhesive blankets and stripping plates are used in the following segments:

- Commercial printing (sheetfed and web)
- Packaging printing
- H-UV / LED-UV
- Label printing
- Security printing
- Envelop printing
- Self adhesive blankets
- Under blankets
- Press-ready blankets



Registered trademarks



www.atece.com

info@atece.com • T +31 (0)251 31 91 09

AtéCé Graphic Products

Based in the Netherlands, AtéCé Graphic Products is a leading manufacturer of a wide range of graphics consumables. AtéCé exports to more than 80 countries around the world via an extensive network of distributors.

Producer

Since 1977, AtéCé has been a producer of, among other things, pressroom chemicals, dispersion and UV coatings and printing inks. AtéCé makes up rubber blankets, stripping plates and washcloth rolls in-house. The production sites are located in the Netherlands, in Uitgeest and Alkmaar. The various products are brought to market under its own brand names, as well as under private labels or as an OEM product.

Distributors

AtéCé has a strong global network of distributors. Quality is an important trademark. As one of the few independent players in the market, AtéCé has a large degree of autonomy. AtéCé is a family business, this guarantees total engagement, accessibility and continuity.

MANUFACTURER
SINCE 1977



No rights can be claimed from this publication. Version 19.03